

REED SWITCH

ORD9215

General Purpose Miniature

■ GENERAL DESCRIPTION

The ORD9215 is a small single-contact reed switch designed for general control of medium-level loads less than 100 V. The contacts are sealed within the glass tube with inert gas to maintain contact reliability.

■ FEATURES

- (1) Reed contacts are hermetically sealed within a glass tube with inert gas and do not receive any influence from the external atmospheric environment.
- (2) Quick response
- (3) The structure comprises the operating parts and electrical circuits arranged coaxially. Reed switches are suited to applications in radio frequency operation.
- (4) Reed switches are compact and light weight.
- (5) Superior corrosion resistance and wear resistance of the contacts assures stable switching operation and long life.
- (6) With a permanent magnet installed, reed switches economically and easily become proximity switches.

■ EXTERNAL DIMENSIONS (Unit: mm)

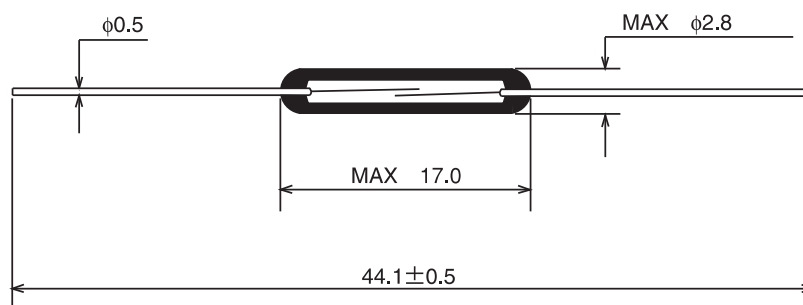

■ APPLICATIONS

- Control equipment
- Communication equipment
- Measurement equipment
- Household appliances

■ ELECTRICAL CHARACTERISTICS

Parameter	Rated value	Unit
Pull-in Value (PI)	10~50	AT
Drop-out Value (DO)	4min	AT
Contact resistance (CR)	100max	mΩ
Breakdown voltage	150min	VDC
Insulation resistance	10 ⁹ min	Ω
Electrostatic capacitance	0.3max	pF
Contact rating	10	VA
Maximum switching voltage	100 (DC/AC)	V
Maximum switching current	0.5	A
Maximum carry current	1.0	A

3

(1) Drop-out Value vs. Pull-in Value

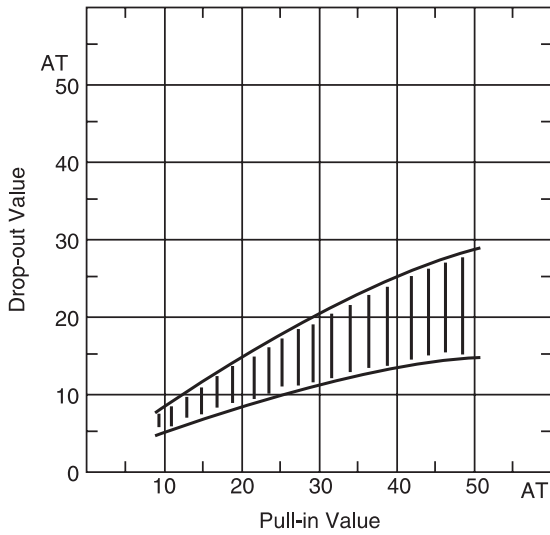

(2) Contact resistance

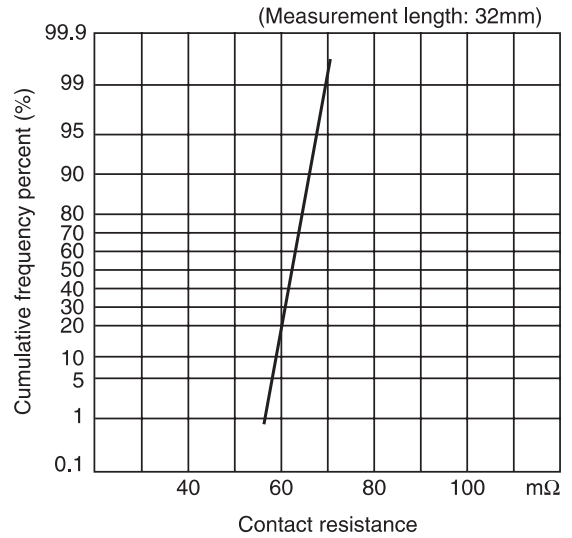

(3) Breakdown voltage

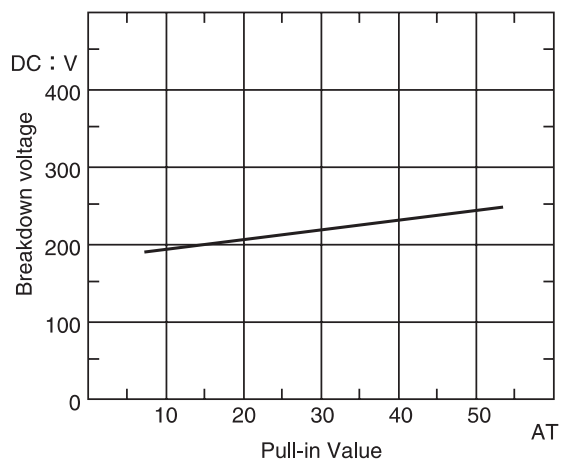

(4) Insulation resistance

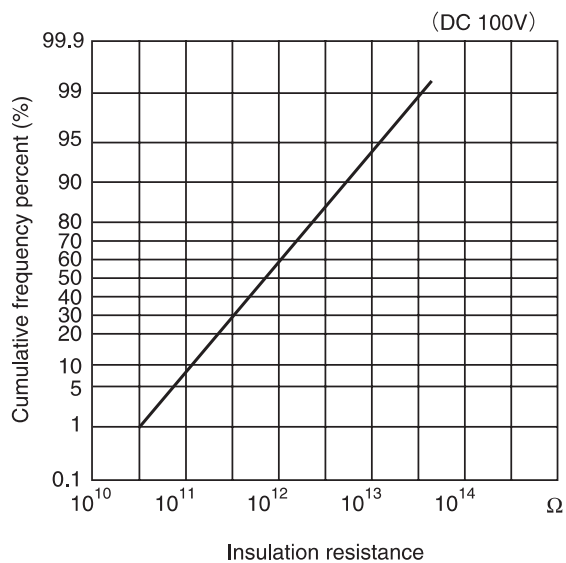

(5) Electrostatic capacitance

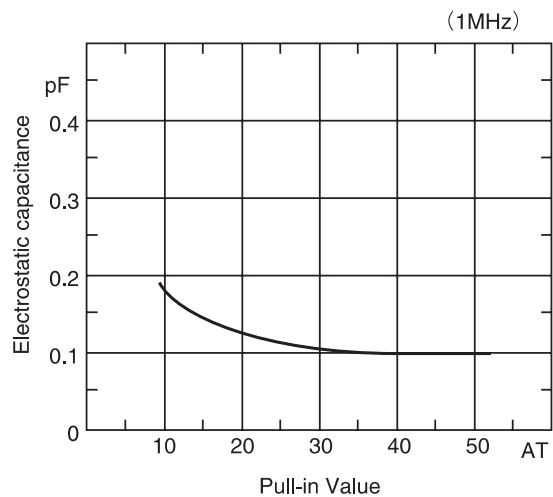

■ OPERATING CHARACTERISTICS

Parameter	Rated value	Unit
Operate time	0.4max	ms
Bounce time	0.4max	ms
Release time	0.05max	ms
Resonant frequency	3700±400	Hz
Maximum operating frequency	500	Hz

(1) Operate time

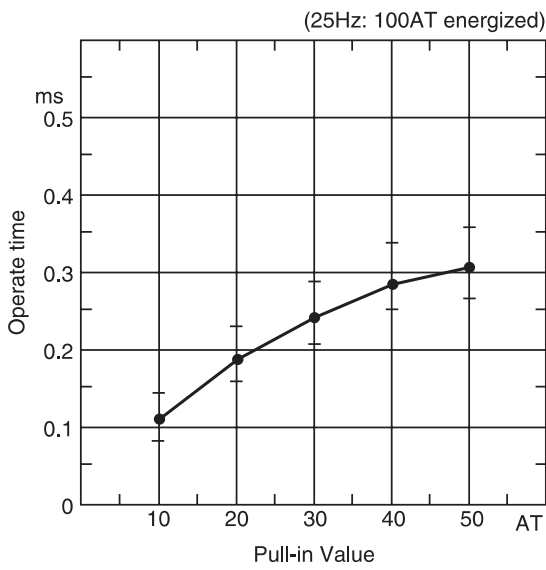

(2) Bounce time

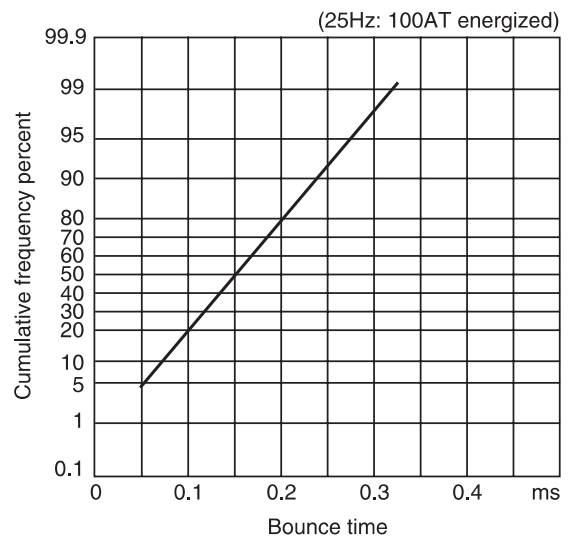

(3) Release time

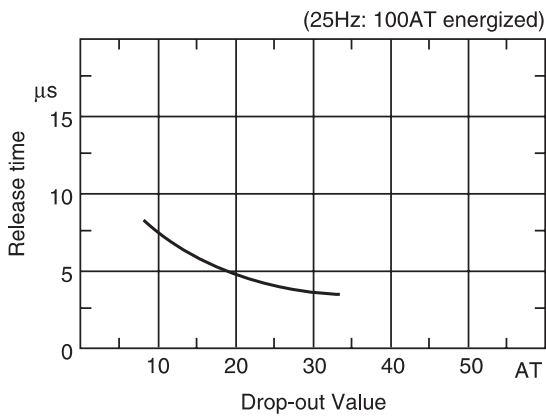

(4) Resonant frequency

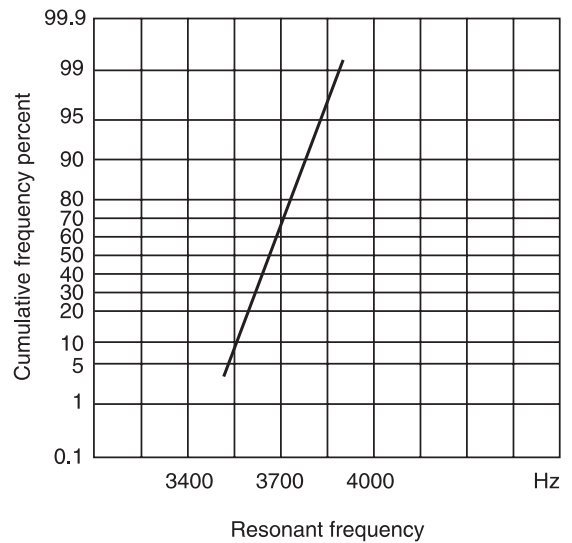

MECHANICAL CHARACTERISTICS

(1) Lead tensile test (static load)

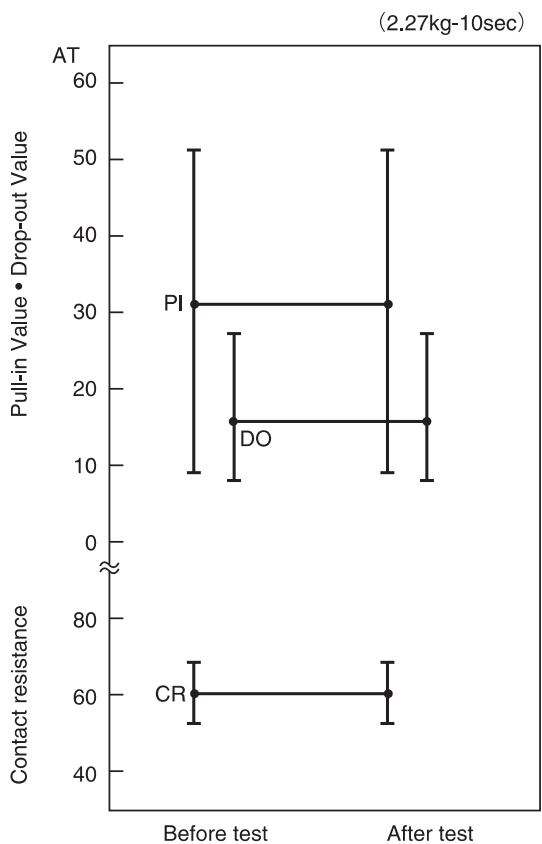

(2) Lead tensile strength

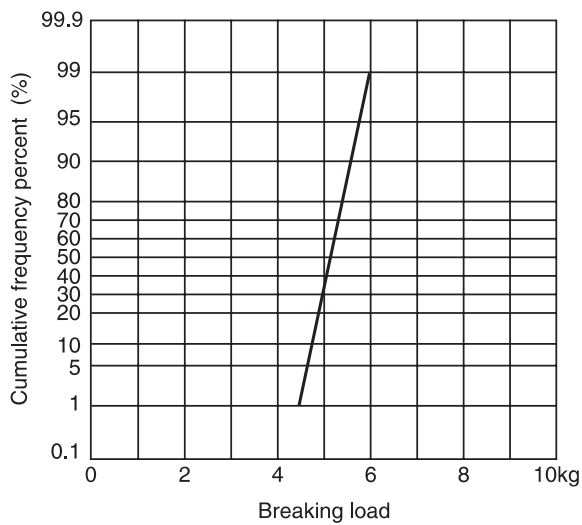

3

ENVIRONMENTAL CHARACTERISTICS

(1) Temperature characteristics

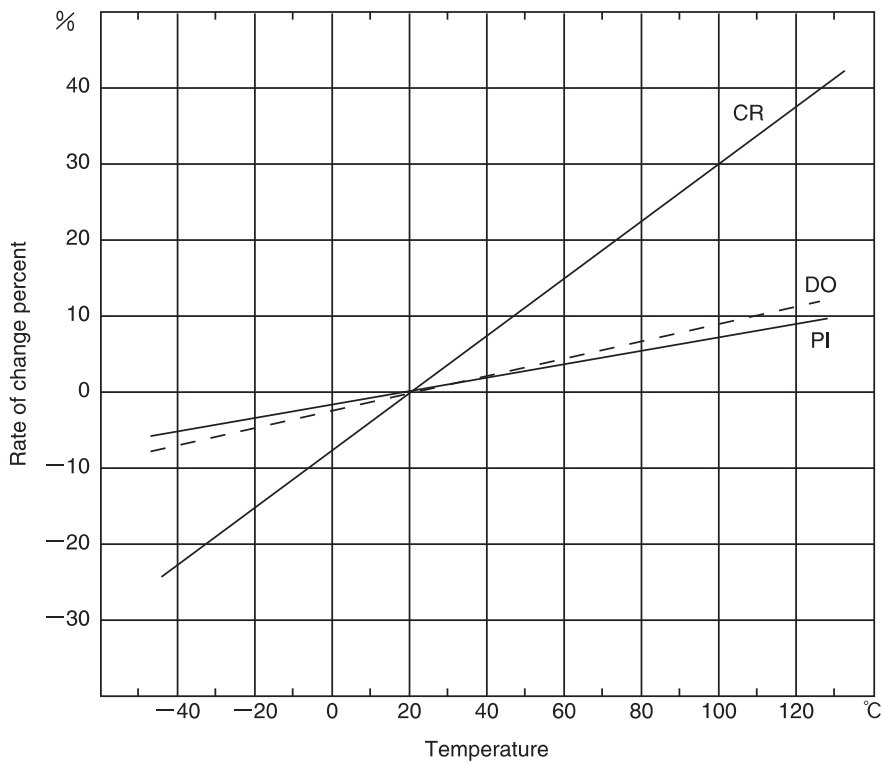

3

(2) Temperature cycle

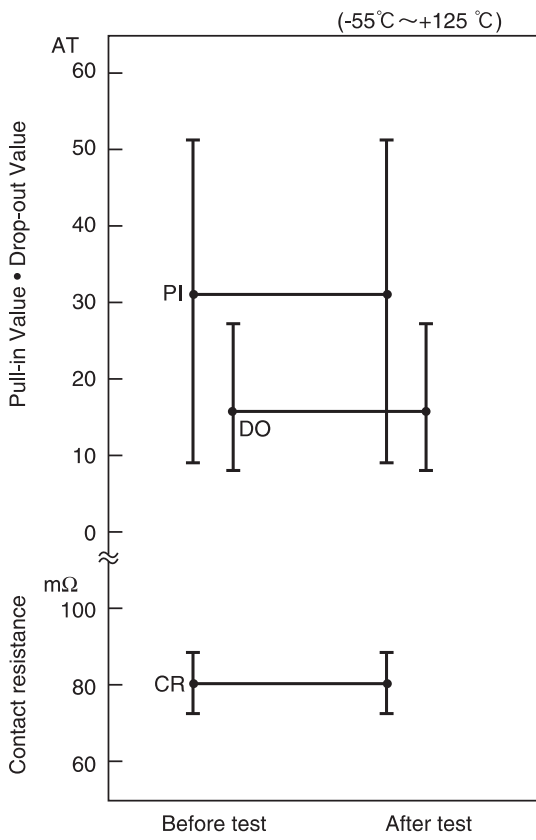

(3) Temperature and humidity cycle

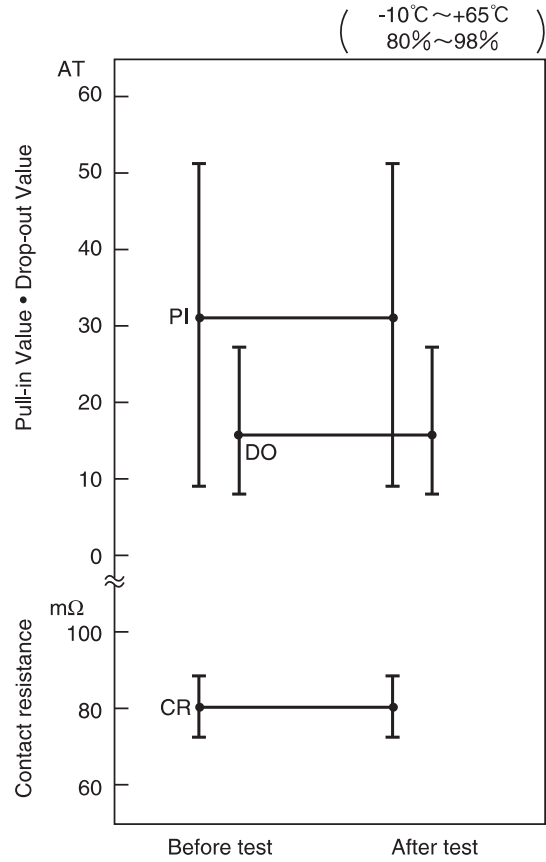

(4) High temperature storage test

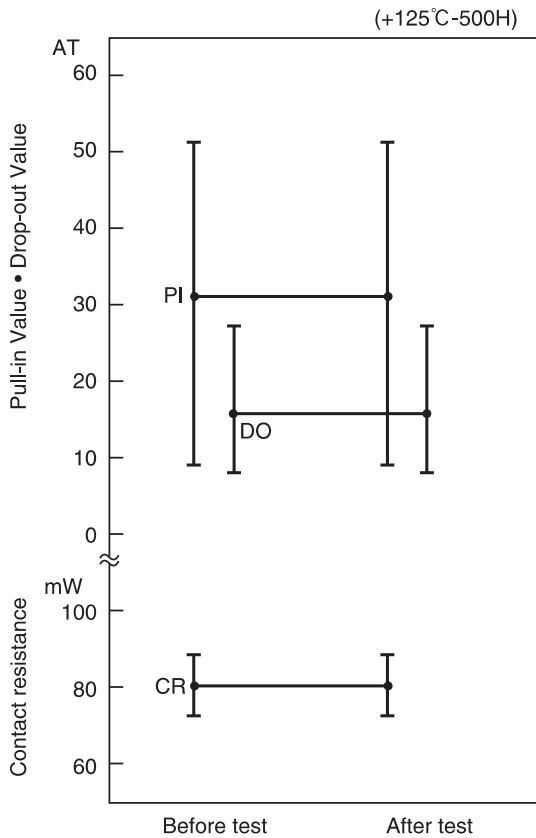

(5) Low temperature storage test

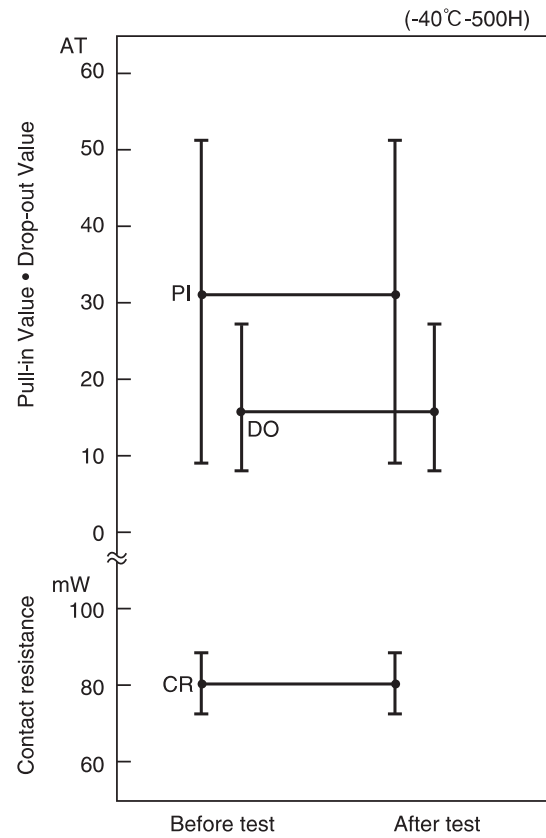

(6) Shock test

1) Electrical characteristics

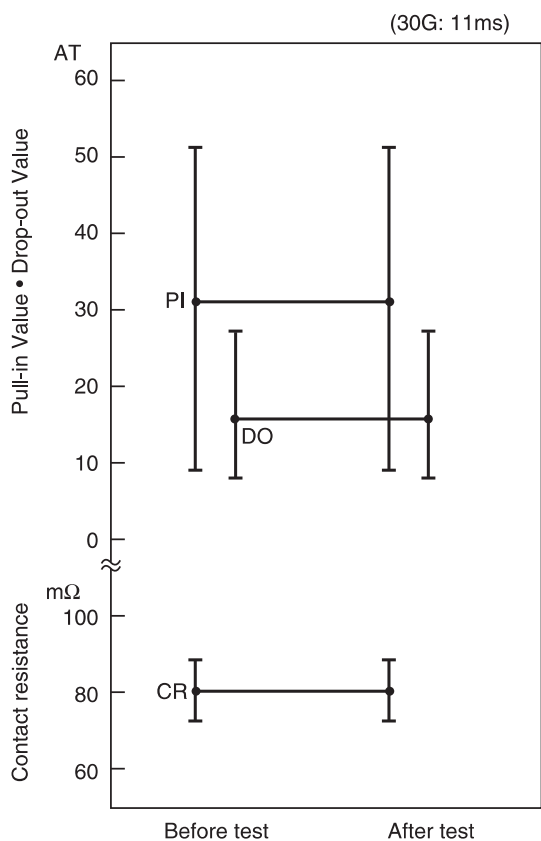

2) Misoperation area

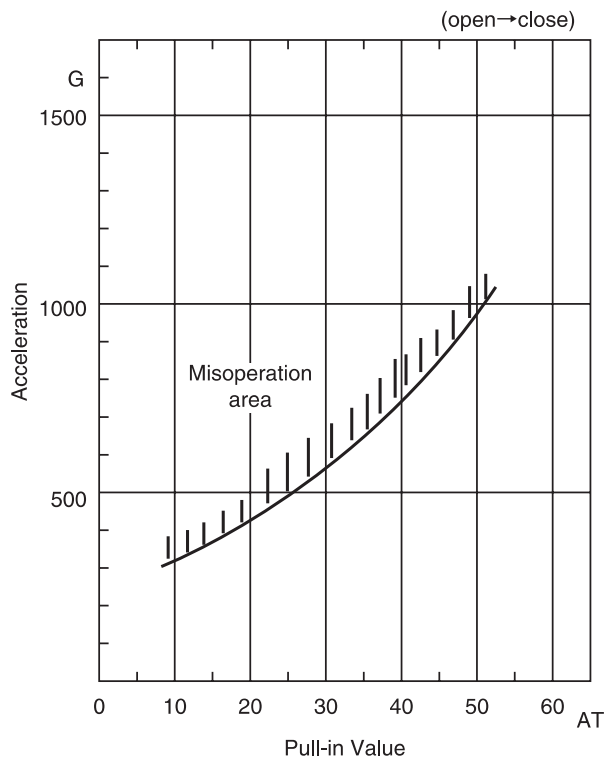

3

(7) Vibration test

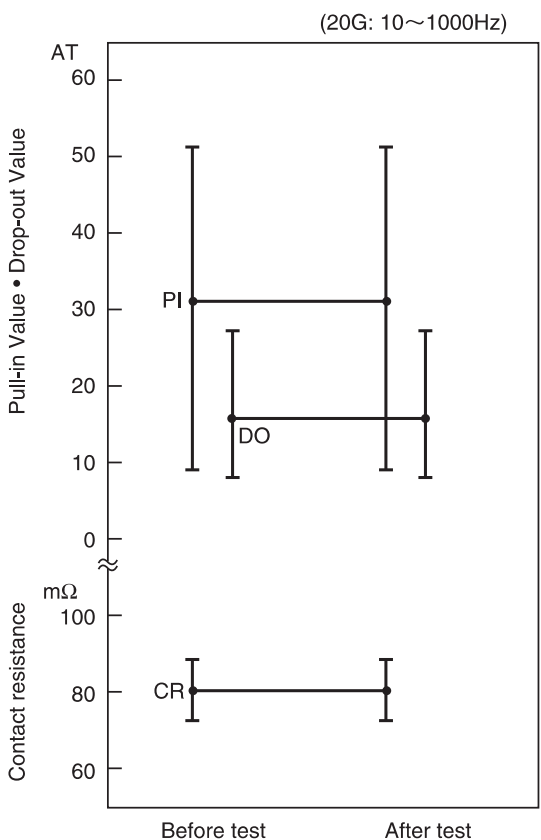

■ LIFE EXPECTANCY DATA: ORD9215

Load conditions
 Voltage: 5VDC
 Current: 100µA 1mA , 5mA
 Load: Resistive load

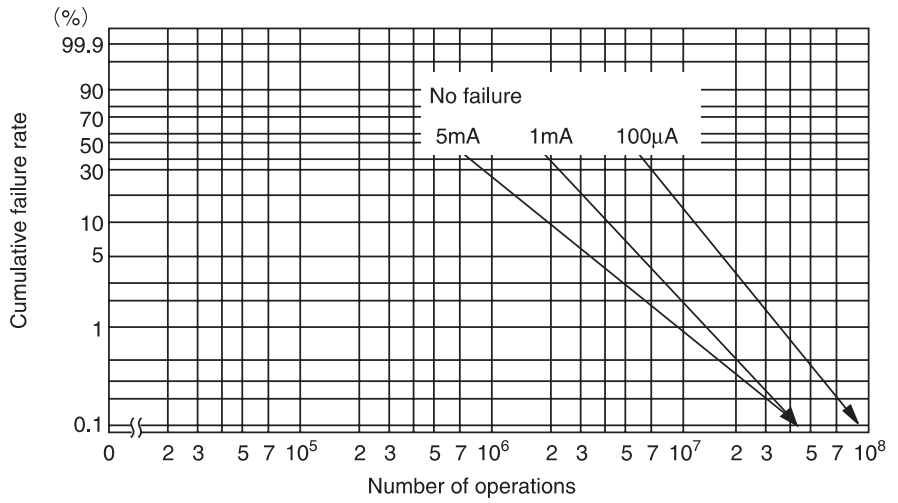

* Arrow indicates number of operations where test was completed.

3

Load conditions
 Voltage: 12 VDC
 Current: 5mA, 10mA, 100mA
 Load: Resistive load

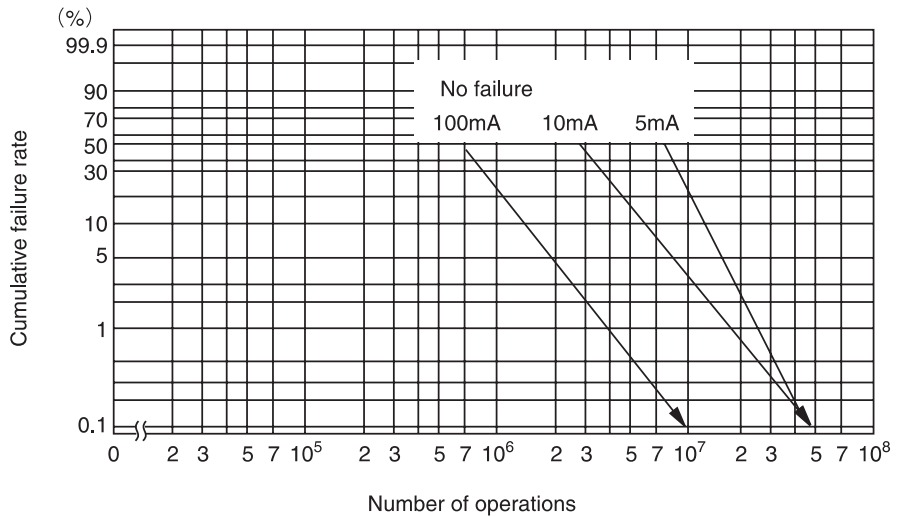

* Arrow indicates number of operations where test was completed.

Load conditions
 Voltage: 24 VDC
 Current: 100mA, 200mA, 400mA
 Load: Resistive load

